

Product Data Sheet

Polyamide Metric Cable Glands

Description:

- For the retention, strain relief and sealing of unarmoured cables for standard industrial applications.
- Easy assembly - install cable gland, insert cable and tighten cap.
- Wide cable clamping range.

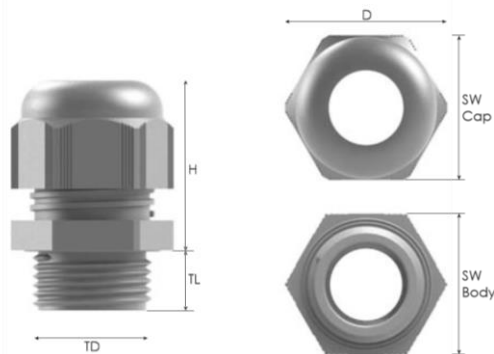

Part No.*	Unit of Supply	Clamping Range Ø min-max mm	Thread Dia. (TD) mm	Thread Length (TL) mm	Spanner Width (SW) mm	Outer Dia. (D) mm	Max. Height (H) mm
CG/LNM12	50	3.0 - 6.5	12	8	15	16.9	22.5
CG/LNM16	50	5.0 - 10.0	16	10	22	25.0	30.0
CG/LNM20S	50	6.0 - 12.0	20	10	24	27.0	29.5
CG/LNM20S-PK10	10	6.0 - 12.0	20	10	24	27.0	29.5
CG/LNM20	50	10.0 - 14.0	20	10	27	31.0	31.0
CG/LNM20S-PK10	10	10.0 - 14.0	20	10	27	31.0	31.0
CG/LNM20 L LT	50	10.0 - 14.0	20	15	27	31.0	31.0
CG/LNM25	25	13.0 - 18.0	25	10	33	38.0	37.0
CG/LNM25-PK10	10	13.0 - 18.0	25	10	33	38.0	37.0
CG/LNM32	EA	18.0 - 25.0	32	15	42	47.3	41.0
CG/LNM40	EA	22.0 - 32.0	40	18	53	60.0	51.5
CG/LNM50	EA	30.0 - 38.0	50	18	60	67.8	53.0
CG/LNM63	EA	34.0 - 44.0	63	18	65	72.9	53.0

All glands supplied with washer and locknut as standard.

* Suffix **B** (Black RAL 9005) **G** (Light grey RAL 7035) **DG** (Dark grey RAL 7001)
W (White RAL 9003) **R** (Red RAL 53025) **BL** (Blue RAL 5015)

(NB colours limited on certain sizes

- 40mm, 50mm & 63mm only available in black and light grey)

Thread type Technical Details







Material		PA 6 (Polyamide 6)
Seal		CR (Chloroprene Rubber)
Protection Class		IP68 5 bar (30 min.) IP66
Flammability		V2 according to UL94
Operating Temperature	Permanent	-20 °C to +100 °C
	Intermittent	-30 °C to +150 °C
Thread Type		Metric EN 60423

Chemical Characteristics

Resistant to:

Acids - high concentrate (conditionally resistant).	Acids - low concentrate
Fuel DIN gasoline / super	Fuel DIN diesel
Mineral oil	Vegetable oils and fats
Leys - low and high concentrate	

Approvals

	Standard		File Number
	VDE	Acc. to DIN EN 62444	134171
	CSA	Acc. to CSA C22.2	115116-0-000
	UL	Acc. to UL514	E199260
	UV	Acc to UL514B §8.26.7	Sercovam Res 107572
	CE		
	RoHS		